



ISCHEBECK[®]
TITAN

Shoring System Ischebeck Megashore

The aluminum shoring system

- The world's leading shoring system
- Fast and versatile
- Lightweight, yet exceptionally strong



Megashore Support System

The Megashore support system is recognized as the leading product in its field by many professionals in the construction and civil engineering industries.

Comprising two main components, legs and frames, together with a comprehensive range of accessories, the Megashore support system offers one of the quickest, most effective and versatile means of providing rapid support and access solutions in an enormous variety of situations.

The system can be used in both 'flying table' and erect and dismantle applications and is ideal for multi-storey structures, water reservoirs and soffit situations where mobility and ease of handling are required.

With the majority of components being manufactured from high grade aluminum to patented designs, the Megashore support system possesses an exceptionally high strength to weight ratio which facilitates rapid erection, whilst its excellent corrosion resistance and robust build quality assure long term durability.

The Megashore support system is designed to reduce labor costs, increase site efficiency, improve safety and meet the demands of today's construction and civil engineering techniques.



- Lightweight components can be easily handled by one man
- Megashore can be loaded up to 22,050 lbs. per leg
- 7'-10" of jack adjustment with jacks top and bottom
- Two components for fast, efficient erection and dismantling
- No loose fittings
- Rigid connection between Megashore legs and frames self-aligns the system
- Continuous vertical slots on the Megashore legs allow Megashore ledger frames to be positioned at convenient working heights
- One system suitable for erect and dismantle shoring and large, rigid flying tables for versatility and economy
- Modular components easily adapt to height and width variations
- Accessories include rocking headplates, guard post brackets, access platforms, cantilever frames and a full range of safety components.



Megashore Legs and Extension Legs

Megashore legs are available in three sizes, each with continuous vertical slots to allow ledger frames to be fitted quickly and securely at the optimum height. Megashore screw jacks can be fitted at the top and bottom of each leg, offering vertical adjustment up to 7'-10".

Megashore extension legs are available in six sizes. Together with Megashore legs every shoring height can be reached.

Weight Legs

Size 2	39.60 lbs.
Size 4	50.60 lbs.
Size 6	63.80 lbs.

*Note: Length of Megashore legs includes headplate and iflon disc.

Weight Extension Legs

0.50	9.46 lbs.
1.00	12.54 lbs.
1.25	18.70 lbs.
2.00	27.56 lbs.
3.00	40.79 lbs.
5.00	52.80 lbs.

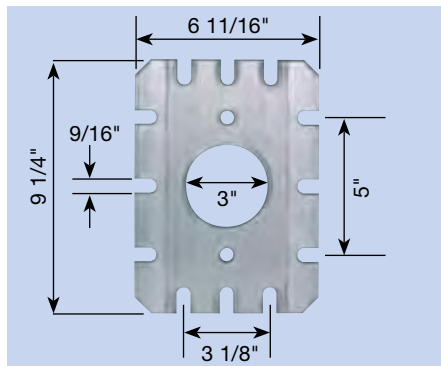
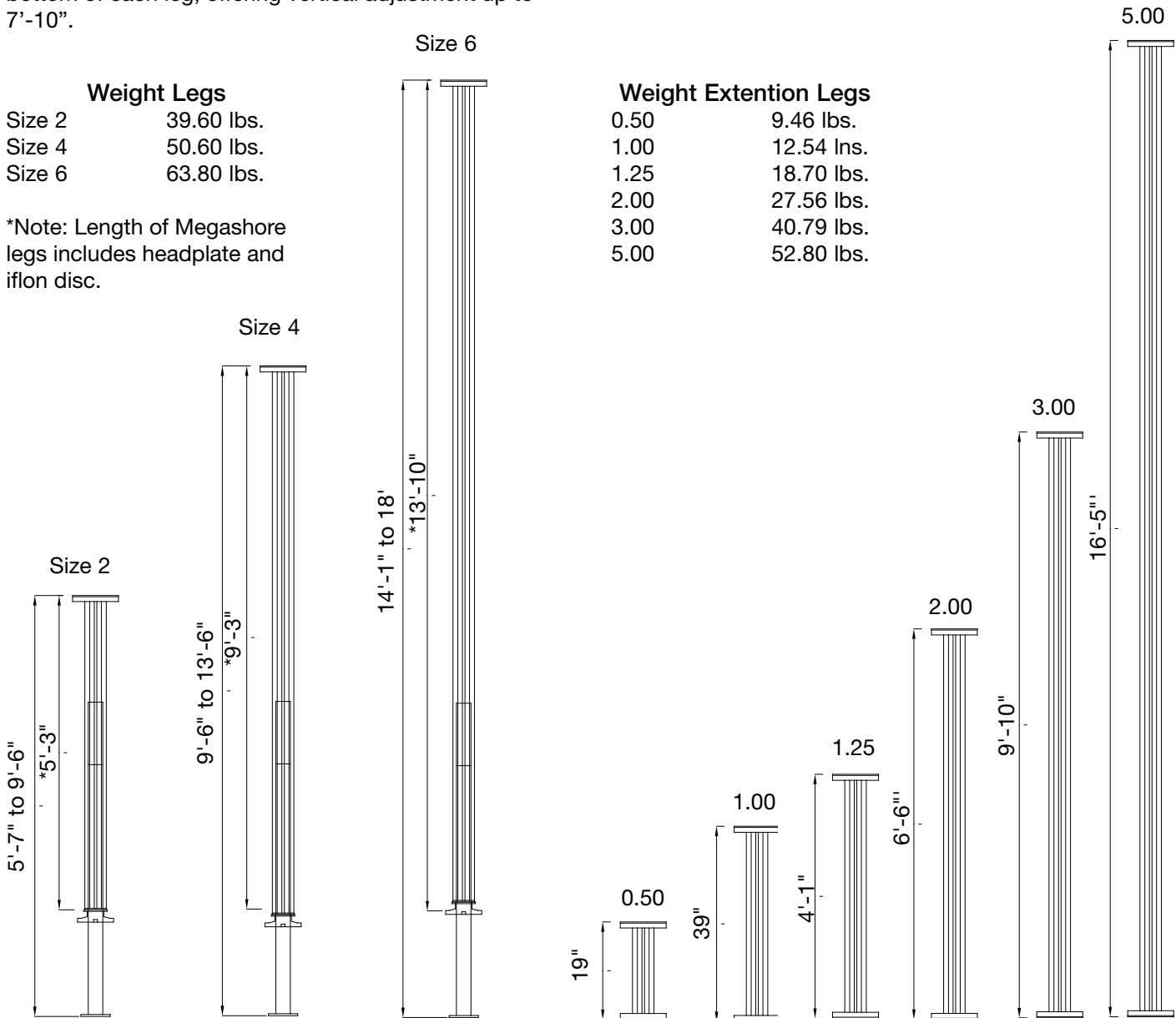

Headplate

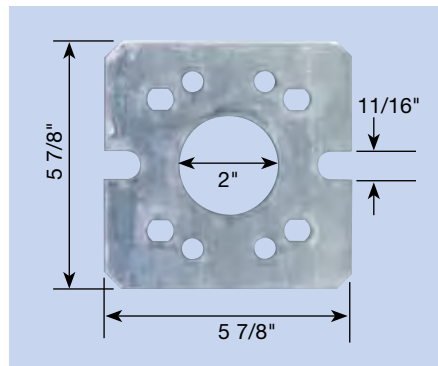

Baseplate



Retainer clips

HV Legs and Extension Legs

HV legs are available in two sizes, the Standard Leg and the Maxi Leg. Together with the 1.25 extension leg and the connection brackets, heights up to 36 ft can be reached. The HV leg is a lighter shoring system for normal slabs and heights up to 24 ft. The Megashore ledger frames can be used with the HV legs for stiffness and to build towers and tables.

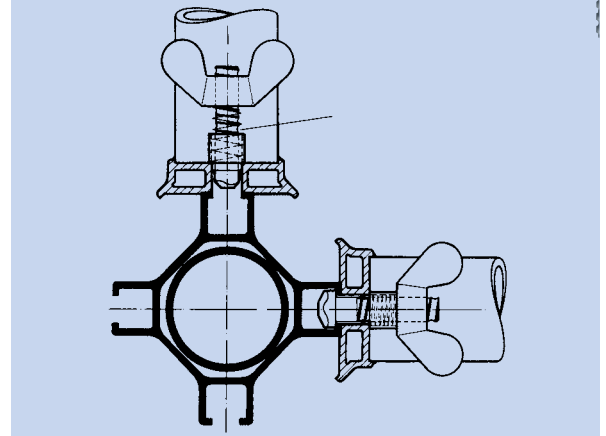
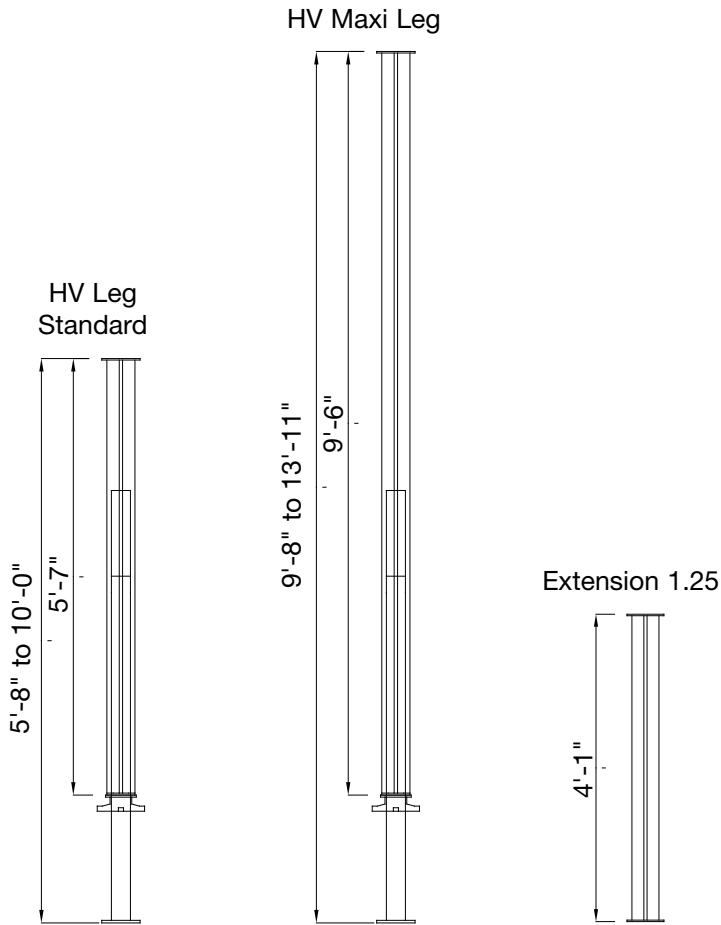

Weight Legs

HV Prop standard	33.88 lbs.
HV Maxi Prop	46.20 lbs.
Extension 1.25	11.88 lbs.

*Note: Length of HV legs includes headplate and iflon disc.

Megashore Ledger Frames

A range of six Megashore ledger frames is available. All frames are shown color coded in Ischebeck design drawings.

*Note: Frame dimensions shown are in feet and centre-to-centre of Megashore legs.

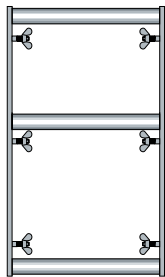
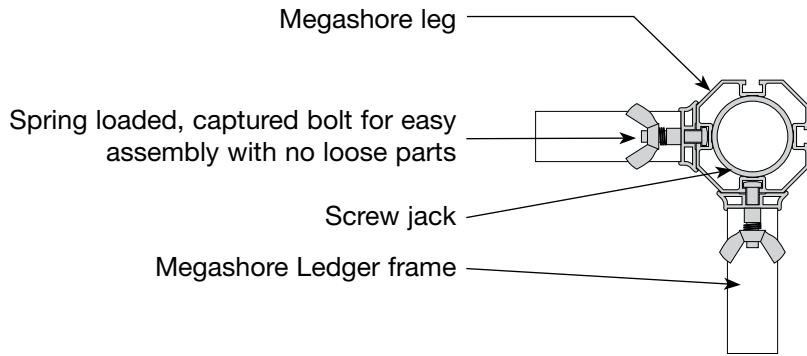

● 600 (12.32 lbs) = 2'

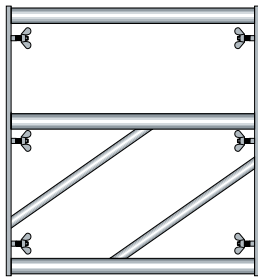

● 900 (16.5 lbs.) = 3'

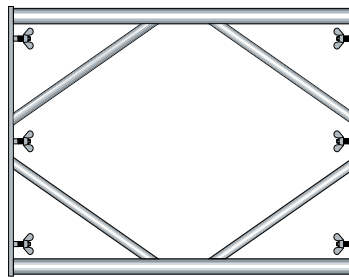

● 1200 (16.72 lbs.) = 4'

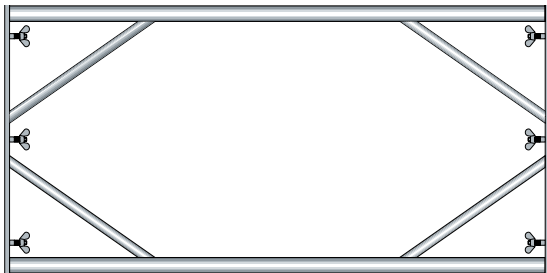

● 1800 (21.34 lbs) = 6'

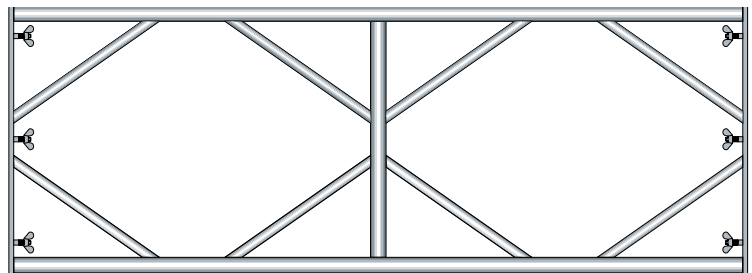

● 2400 (29.70 lbs.) = 8'

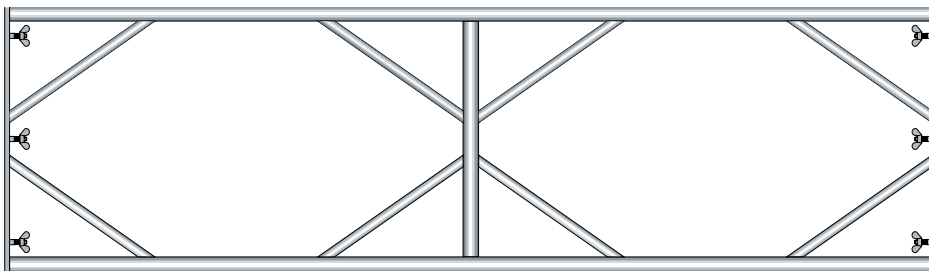

● 3000 (33.88 lbs) = 10'

Megashore Beams

Manufactured from extruded aluminum section, Megashore beams offer a lightweight, easy to handle solution for decking/soffit applications. All secondary beams are shown color coded in Ischebeck design drawings.

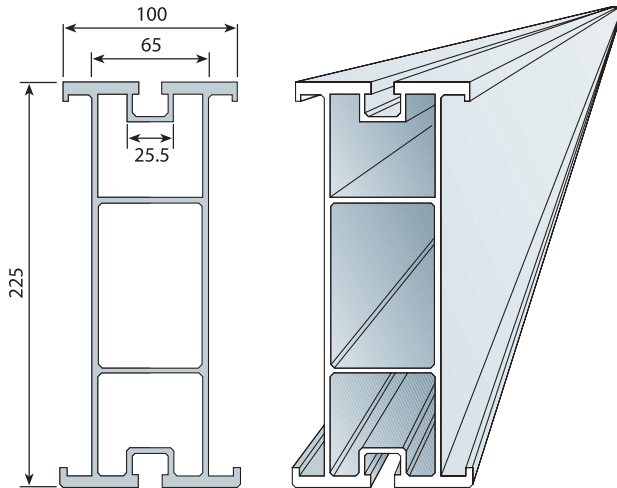

Titan 225 beam

	Area	5,057 in ²
I _{xx}	Moment of inertia	54.00 in ⁴
Z _{xx}	Section modulus	12.16 in ³
E	Modulus of elasticity	9,799,883 lbs/in ²
E.I.	Bending stiffness	31,623 lbs/ft ²
W	Weight	5.94 lbs/ft
M	Resistance moment	21,020 lbs* ft
S	Allowable shear force	20,000 lbs

length (m + ft)

1.2 = 3'-11"
 1.8 = 5'-11"
 2.4 = 7' - 11"
 3.0 = 9'-10"
 3.6 = 11'-10"
 4.2 = 13'-9"
 4.8 = 15'-9"
 5.4 = 17'-9"

length (m + ft)

6.0 = 19'-8"
 6.4 = 21'
 7.2 = 23'-7"
 8.0 = 26'-3"
 9.0 = 29'-6"
 10.0 = 32'-10"
 11.0 = 36'-1"

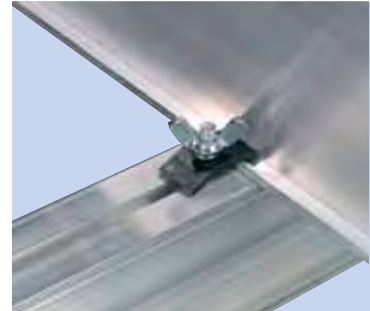

Beam to beam fixing



Megashore Clamp



Headplate to beam fixing



Guardpost bracket
 For fixing of guardposts and handrails at soffit level.

Megashore Loading Graphs

The allowable leg load is determined by the floor to soffit height, the number of ledger frames in height or jack extension

Notes:

It is assumed the formwork is restrained from horizontal movement at the formwork level.

Ledger frames to be fixed in the optimum position.

Maximum distance between ledger frames not to exceed 6'-6" between top and bottom chords of ledger frames. This rule also applies on floor to soffit heights greater than 36'.

On shoring heights over 36 ft, refer to Ischebeck Design Services for advice. On the higher shoring heights, an additional level of frames may be required for ease of erection and stability.

Minimum height to base ratio = 4:1.

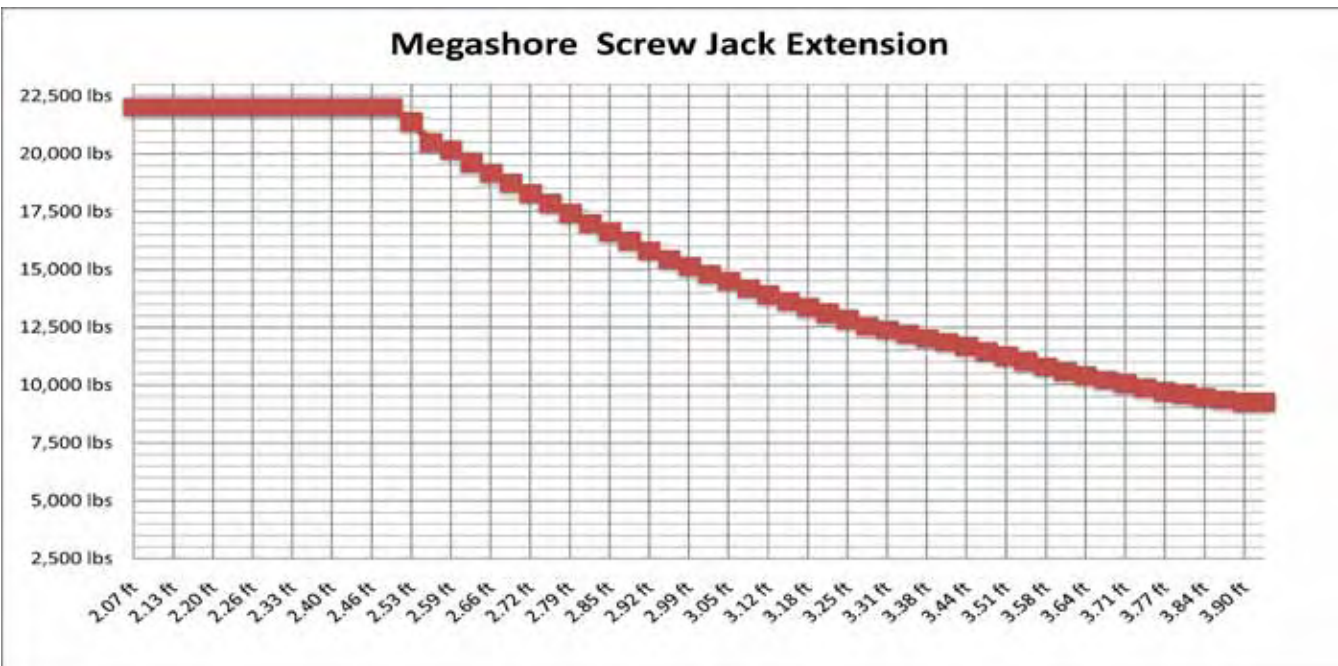
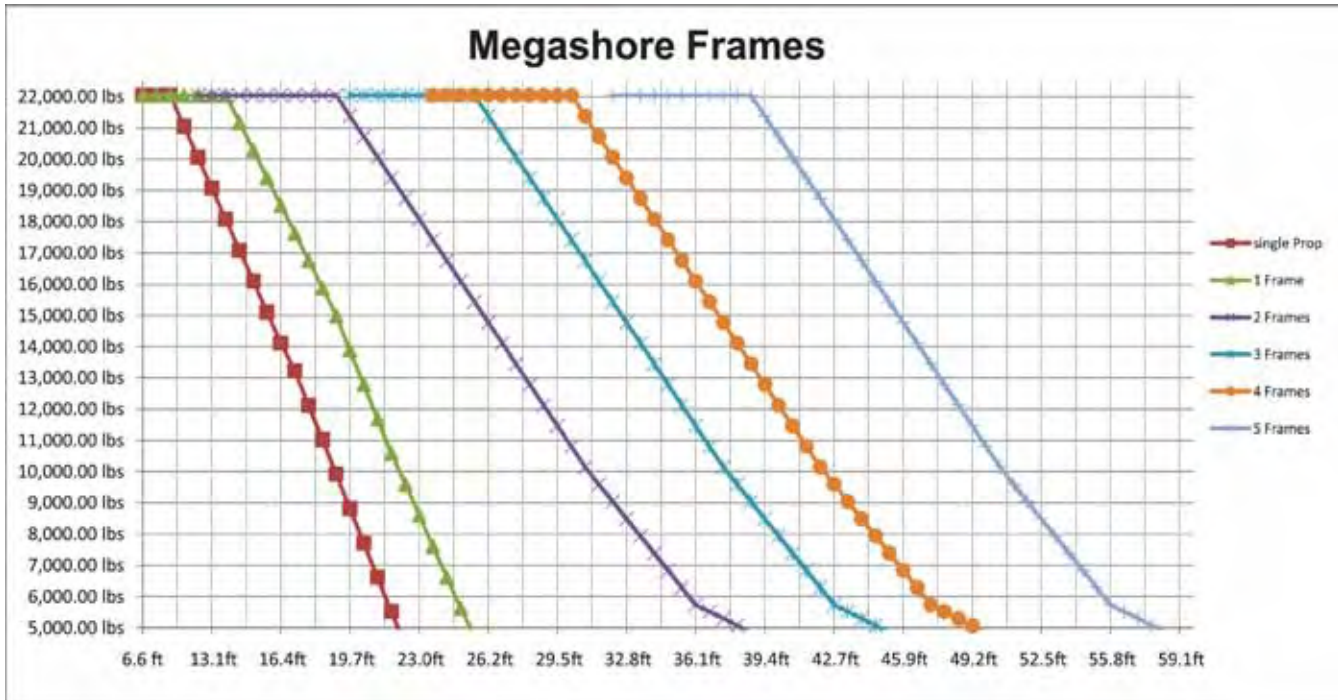

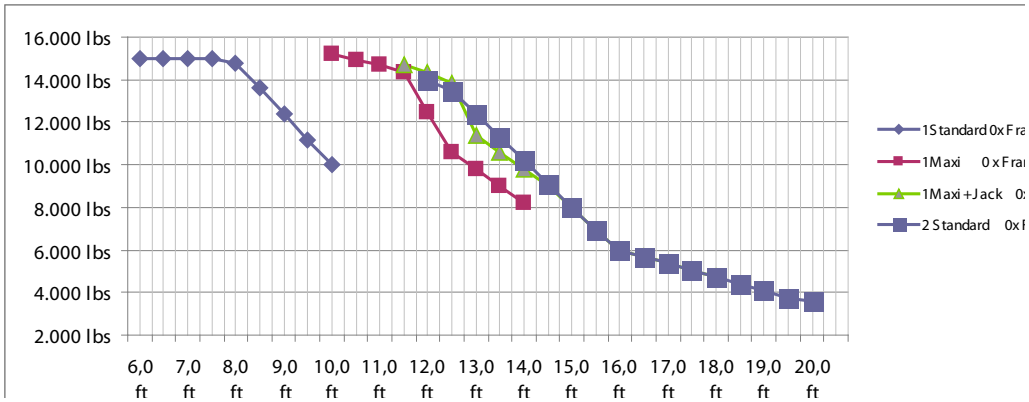

The allowable leg load for the HV legs is in relation to the overall height and the amount of ledger frames in the height. The screw jack extension on top and bottom is not as important as the total height of the legs or towers.

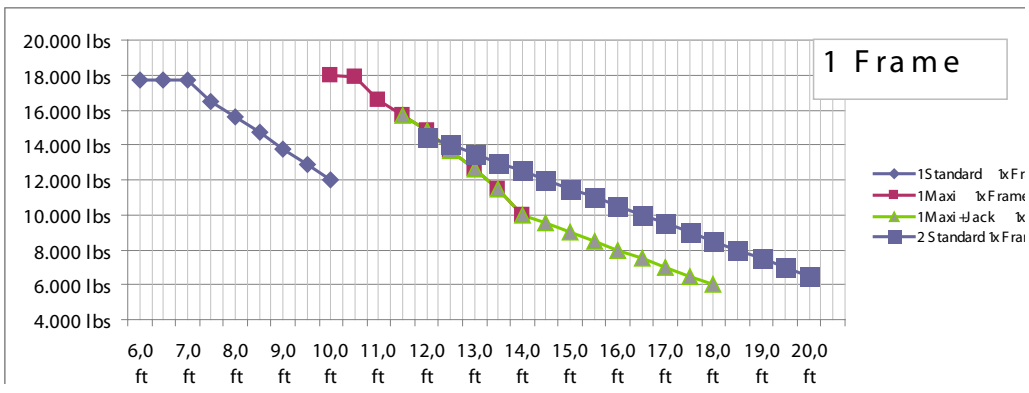

1 Frame

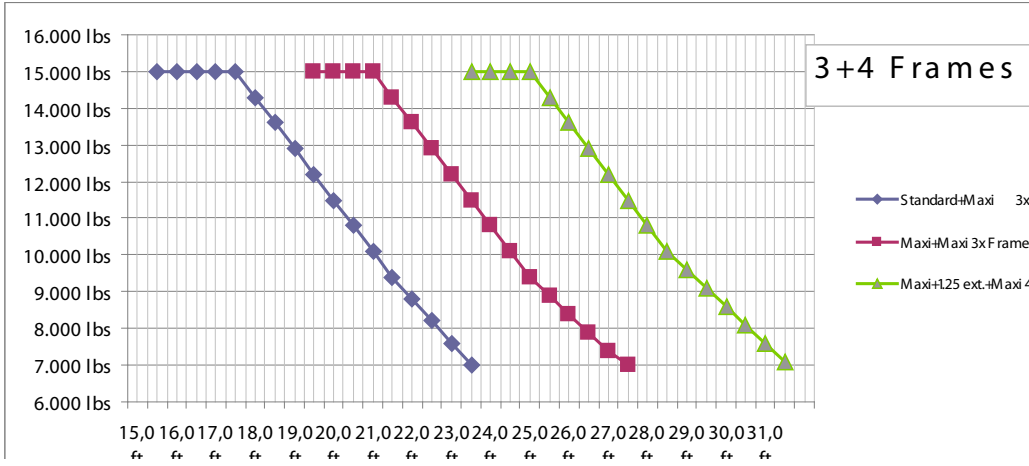
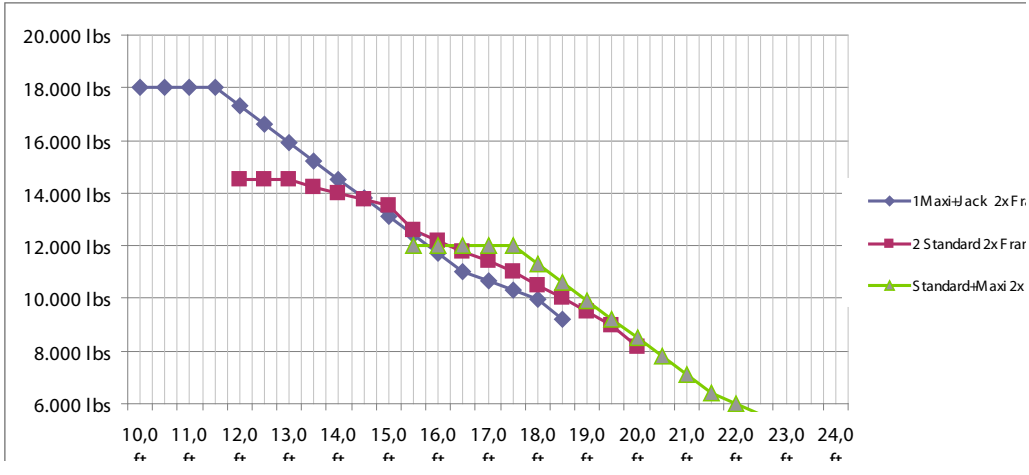

3+4 Frames

Megashore Accessories

The modular Megashore system has been designed to combine maximum flexibility in use with a minimum number of components.

The range of Megashore accessories enhances the versatility of the Megashore support system without significantly adding to the number of components or equipment required.



Megashore Trolley
For moving Titan system when assembled as a tableform.



Megashore spanner
Simplifies jack adjustment.



Iflon Disk/ Retainer Clip
Easy load release
Holds jack in leg



Megashore rocking head plate up to 33 Degrees
For sloping soffits, ramps and other inclined surfaces.

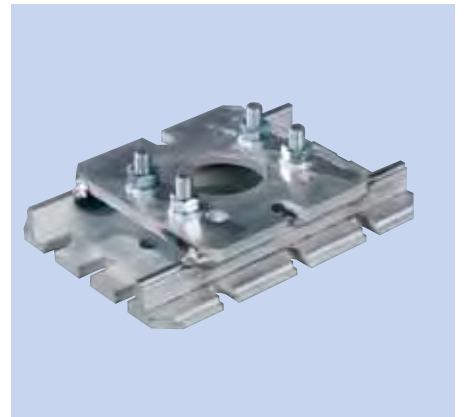
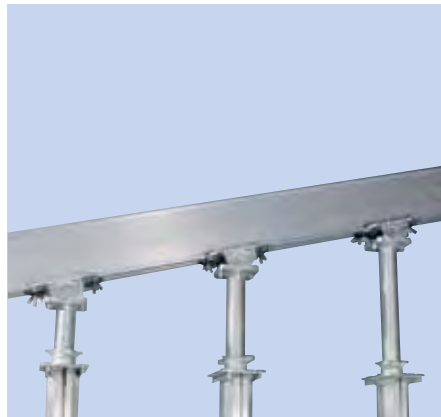

Megashore leg adaptor plate
For connecting to jack base plate.



Megashore connecting bracket
Provides rapid connection between headplates.



Megashore hinge unit
For hinging of legs to clear narrow vertical openings.

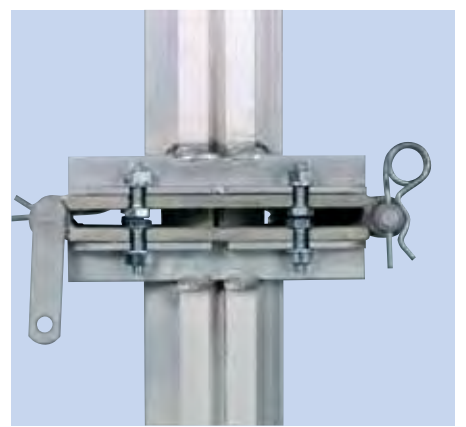

Megashore Erection Sequence



1. Connect ledger frame horizontally between 2 legs. Predetermined ledger frame position measured from headplate.



2. Connect ledger frame vertically to leg.



3. Repeat 2 to form three sides to bay.



4. Repeat 1 to form 4th side of bay and then lift both sides of bay into position.



5. Connect both sides to form a 4 leg tower.



6. Now add additional frames and legs to form Megashore support structure.



7. Place intermediate transoms and scaffold boards in position for fixing of aluminium beams.



8. Fix primary beam to headplate by means of 2 no. Megashore clamps.



9. Position secondary beams and fix with a Megashore clamp at each intersection with a primary beam. Structure is now ready for fixing of plywood.



Your contact person:

The photos reproduced in this brochure represent momentary snapshots of work on building sites. It is therefore possible that certain facts and circumstances do not fully correspond to the technical (safety) requirements.

DIN EN ISO 9001

CERTIFIED QUALITY SYSTEM



DIN EN ISO 9001 / 2000
 Zertifiziert durch DVS ZERT® e. V.
 Registriernummer DE-96-010

ISCHEBECK® . . . technically advanced formwork, shoring, trenching and geotechnical systems

ISCHEBECK USA Inc. · 2770 South Horseshoe Drive Suite 5 · NAPLES, FL 34104
 TEL. 239 403 8522 · FAX. 239 403 8146 · E-MAIL: info@ischebeckusa.com · INTERNET: www.ischebeck.com
 principal office FRIEDR. ISCHEBECK GmbH, Loher Str. 31-79, 58256 Ennepetal, Germany

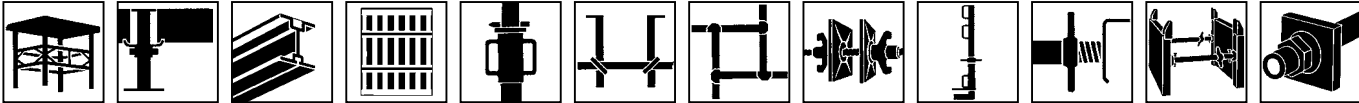

Megashore HV-System Slabforming Systems Wallform Props Beam Forms Column Forms Formwork Ties Rail Posts Struts Trenching Systems Geotechnical Systems